

Safety & Installation Instructions

v1.4-09.23

Fin Medium, Large & Horizontal Pendant Lights Instruction Manual

These instructions are provided for your safety in order to prevent the risk of Fire, Electric shock or Injury. It is vitally important that they are read in their entirety before installing your fitting. Please retain for future reference.

1. If you are in any doubt consult a qualified electrician as to the installation of the fitting. Install in accordance with current IEE wiring regulations. It is recommended that this fitting is installed by a qualified electrician.
2. Ensure that the electrical supply is OFF. Disconnect the electrical supply at the fuse-board.
3. If removing an existing fitting first, note all wiring connections: record which of the house wires is connected to the live, neutral and earth terminals.
4. Carefully identify where the supply cable is (and check there are no other cables in the area) to avoid damage to concealed wiring during installation.
5. Position the light where desired ensuring that there is suitable support adjacent to where you will connect to the house supply and mark position of fixing holes, before drilling appropriate holes as below.
6.
 - a. Brick or masonry: Drill holes into which the wall plugs tightly fit, then insert wall plugs.
 - b. Wood: No hole necessary (unless small pilot hole required), screws can be screwed directly into the timber.
 - c. Plaster/Cavity: Special cavity wall fittings are required, rather than provided fixings. These are widely available from good hardware or DIY store and should come with their own instructions that must be followed. It may be easier to relocate the fitting so that you screw directly into a timber joist or beam.
7. Once desired drop determined, adjust the flex length accordingly. Consult an electrician if in any doubt.
 - Use wire cutters to cut flex at desired length and then remove 15mm of the cotton braid and outer insulation (making sure no damage occurs to the interior cables). Apply electrical tape around the end of the cotton braid to prevent fraying.
 - Remove 5mm of insulation from the conductors, ready to be wired into a connector block.
8. Support the fitting so that no strain is applied to the wiring when making the electrical connections. If necessary get a colleague to help.
9. Electrical connection: this light fitting is double insulated, DO NOT connect to an Earth wire or terminal. Make connections using the connector block, following the diagram below. A small flat-head screwdriver is required.

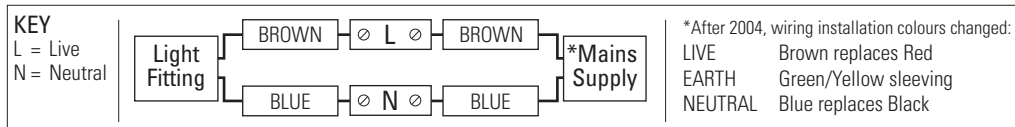

10. Double check all the connections are secure and that no loose strands of wire are left out of the connector. Ensure that the lid of the connector block is closed securely.
11. Check that no wires are trapped behind or within the fitting and complete the installation, see installation instructions inside.
12. Fit the correct type and wattage of lamp (or less). Be careful not to overtighten the lamp.
13. Switch on at the fuse-board. Your light fitting is now ready for use.

Other Important Information

Switch off at mains before changing lamp(s). Never fit a lamp of greater wattage than recommended. Ensure children do not play with the light fitting. Dispose of old lamps carefully. Never leave a fitting without a lamp in position (or someone can accidentally touch the contacts). Adjust fitting only when power to the fitting is off and has been left to cool. If the external flexible cable or cord of this luminaire is damaged, it shall exclusively be replaced by the manufacturer or his service agent, or similar qualified person, in order to avoid a hazard. For use in a dry, indoor environment only. Ensure the fitting does not come into contact with any liquids.

Cleaning and Maintenance

Bone china can be cleaned using a soft damp cloth, or mild (non abrasive) detergent if necessary. Switch off power to the fitting before cleaning. Spare parts are available for this product; contact us using the information below.

Established in 1990, Original BTC manufactures relaxed, familiar lighting for traditional and contemporary homes.

All products are hand-assembled in Oxfordshire from high quality components, produced in the UK.

ORIGINALBTC.COM

+44 (0)1993 882 251

UNIT 21 / 22 AVENUE ONE, STATION LANE, WITNEY, OX28 4XZ, ENGLAND



ORIGINAL BTC
BRITISH LIGHTING MANUFACTURERS
LONDON • NEW YORK • PARIS

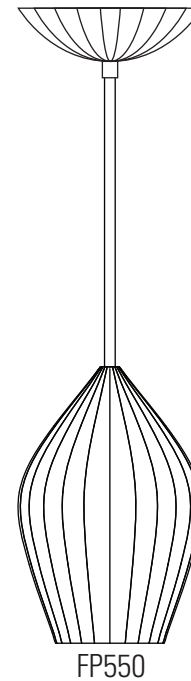

FP550

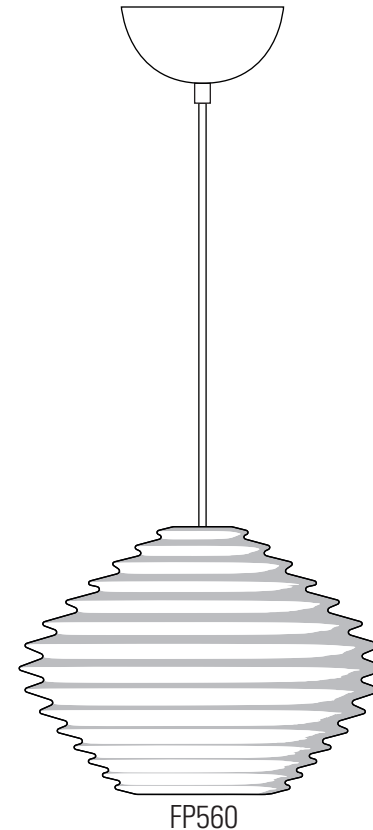

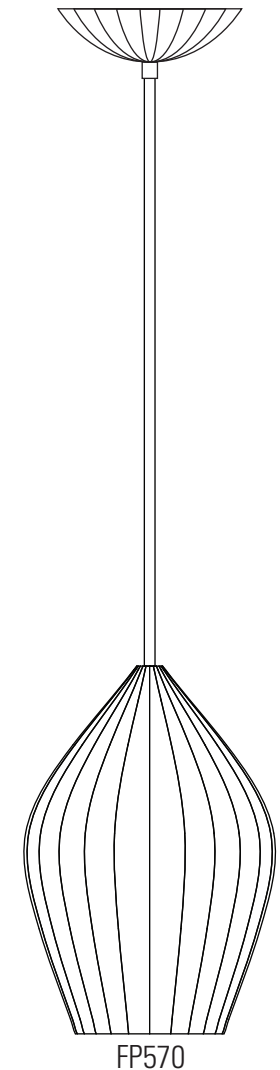

FP560



FP570

Fin Medium, Large & Horizontal Pendant Lights | 230V AC 50Hz | IP20

- FP550 Fin Medium
- FP570 Fin Large
- FP560 Fin Horizontal

LAMP GUIDANCE				
BASE	SHAPE	TYPE*	WATTAGE**	
			FP550	FP560 & FP570
 E27	 GLS	 BALL	INCANDESCENT x	N/A
			CFL x	N/A
			ECO-HALOGEN x	N/A
			LED ✓	6W

* Warm white (2700k) low energy lamps recommended.
** Wattage value provided as a guide to suitable lamps. Lower wattage than stated may be used.

Contents

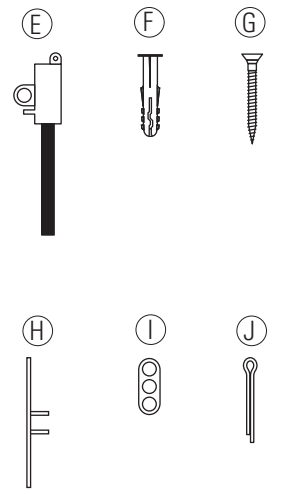
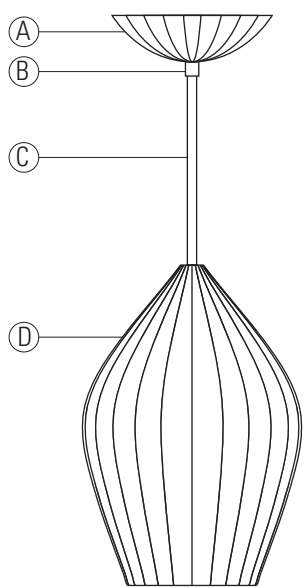

- Contents**
- A Ceiling rose
 - B Grub screw cord grip
 - C Cable
 - D Shade
 - E Connector block
 - F Rawl plug (x2)
 - G Fixing screw (x2)
 - H Fixing bracket
 - I 3-Hole cord grip
 - J Cotter pin

- Tools Required**
- Cross head screwdriver
 - Small flat-head screwdriver
 - Drill (if holes are required)

Supply Cable Preparation

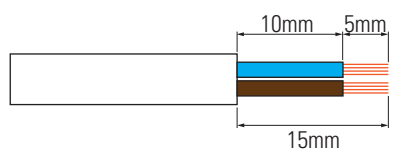

Please prepare the supply cable as shown. Note the maximum conductor size 1.5mm².

Installation Diagram

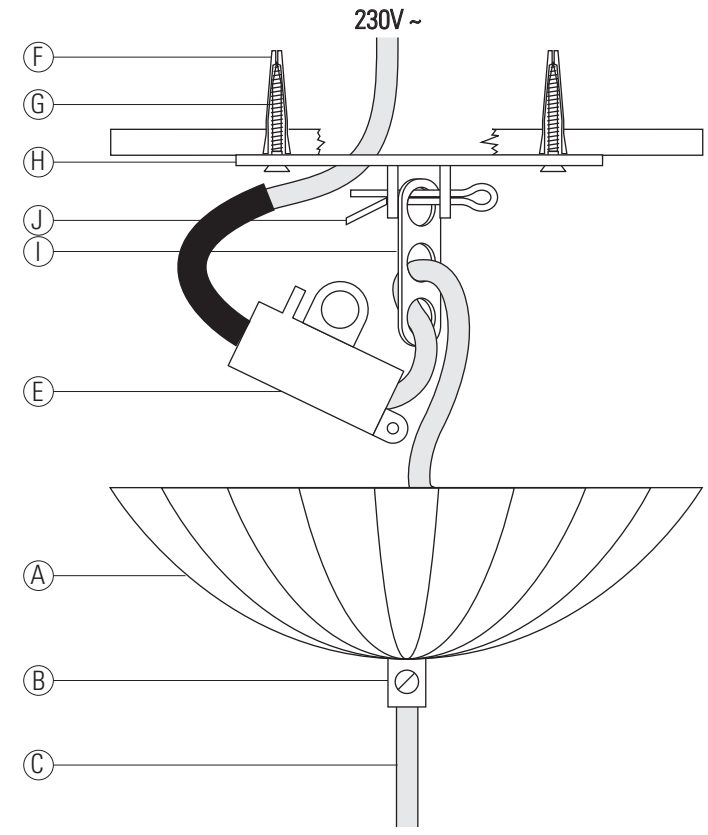

Installation Instructions

- STEP 1** - Read all the instructions on the back page before starting any work.
- STEP 2** - Mark and drill suitable fixing holes, referring to points 1 to 6 on the back page.
- STEP 3** - Secure the fixing bracket (H) to the ceiling using the screws (G) and rawl plugs (F) provided, or other suitable means as described in point 6 on the back page.
- STEP 4** - Determine the desired drop of the fitting, shortening the cable if necessary and preparing it as shown in the diagram on the opposite page. Leave at least 10cm of cable to wire the fittings into the connector block.
- STEP 5** - Feed the cable through the MIDDLE then BOTTOM holes of the 3-hole cord grip (I) and pull tight.
- STEP 6** - Secure the 3-hole cord grip (I) to the fixing bracket (H) using the cotter pin (J). Bend back one of the 'legs' of the cotter pin to prevent it from coming loose.
- STEP 7** - Make the connections to the main supply using the connector block (E) provided. Refer to points 8 to 10 on the back page.
- STEP 8** - Push the ceiling rose (A) up the cable until it sits flush against the ceiling. Secure it in position by tightening the grub screw cord grip (B). Take care not to overtighten, as this can damage the cable.

PLEASE READ THE INSTRUCTIONS ON THE REVERSE BEFORE YOU BEGIN INSTALLING YOUR LIGHT