

kdl*n*

ASSEMBLY INSTRUCTIONS
ISTRUZIONI DI MONTAGGIO
INSTRUCCIONES DE MONTAJE
MONTAGE-ANLEITUNG
INSTRUCCIONES DE MONTAJE
ИНСТРУКЦИИ ПО МОНТАЖУ

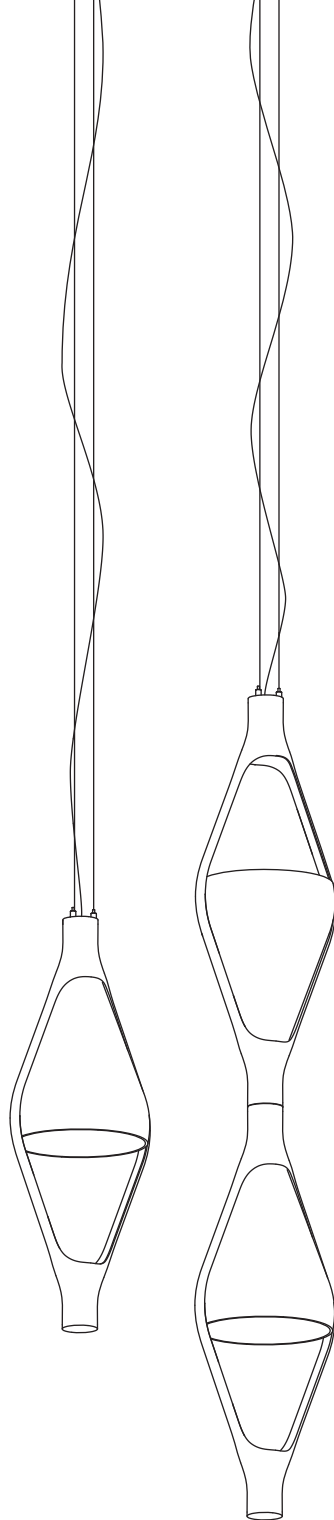

VICEVERSA

NOÈ DUCHAUFOR LAWRENCE

WARNING

The safety is guaranteed by the appropriate use of the following instructions, so you must keep them.

Always disconnect the main voltage before working on the appliance.

Never use abrasive products or aggressive detergents for cleaning the lamp.

If the external cable of this appliance is damaged, it must be replaced by the manufacturer, its after sales service or other equivalent qualified person only in order to avoid any danger.

Kdln will not provide a replacement until the nature of defect has been determined.

The symbol  indicates that the product must be thrown out in a different manner than with the urban trashes.

ATTENZIONE

La sicurezza dell'apparecchio è garantita con l'uso appropriato delle seguenti istruzioni, pertanto è necessario conservarle.

Togliere sempre la tensione prima di operare sull'apparecchio.

Per pulire la lampada non usare mai prodotti abrasivi o detergenti aggressivi.

Se il cavo esterno di questo apparecchio viene danneggiato, deve essere sostituito esclusivamente dal costruttore, dal suo servizio assistenza, o da personale qualificato equivalente, al fine di evitare pericoli.

Kdln non effettuerà nessuna sostituzione se non dopo aver accertato la natura del difetto.

Il simbolo  indica che il prodotto deve essere smaltito in modo differenziato dai rifiuti urbani.

ATTENTION

La sûreté de l'appareil n'est garantie qu'en suivant scrupuleusement les instructions ci-après.

Il est donc nécessaire de les conserver.

Isoler l'appareil du secteur avant toute manipulation.

Pour nettoyer la lampe, ne jamais utiliser de produits abrasifs ou de nettoyeurs agressifs.

Si le câble externe de cet appareil est endommagé, il doit être remplacé uniquement par les soins du constructeur, par son service après-vente ou bien par le personnel équivalent, et ce afin d'éviter tout danger.

Kdln ne remplacera aucun appareil sans en avoir pu vérifier le défaut.

Le symbole  indique que le produit doit être éliminé d'une autre façon que celle avec les déchets urbains.

ACHTUNG

Die Sicherheit dieses Artikels wird nur durch die strikte Befolgung der nachfolgenden Betriebsanleitung gewährleistet.

Bitte heben Sie diese unbedingt auf.

Vor allen Arbeiten ziehen Sie bitte den Stecker aus der Dose.

Für die Reinigung der Lampe niemals Schleifmittel oder aggressive Reinigungsmittel verwenden

Sollte das Außenkabel der Lampe beschädigt werden, ist es ausschließlich vom Service-Dienst des Herstellers oder gleichwertigen, qualifiziertem Personal auszutauschen, um somit Gefahren zu vermeiden.

Kdln leistet grundsätzlich erst nach einer gründlichen Überprüfung Ersatz.

Das Symbol  zeigt an, dass das Produkt getrennt vom Stadtmüll entsorgt werden muss.

ATENCIÓN

La seguridad del aparato está garantizada sólo con el uso apropiado de las instrucciones siguientes,

por lo tanto es necesario atenderlas puntualmente.

Desconectar siempre la alimentación antes de trabajar en el aparato.

Nunca utilice productos abrasivos o detergentes agresivos para limpiar la lámpara.

Si el cable externo de este aparato se deteriora será necesario sustituirlo; la sustitución podrá efectuarla exclusivamente el fabricante, su servicio de asistencia o personal cualificado equivalente para evitar peligros.

Kdln no efectuará sustitución alguna hasta después de haber verificado la naturaleza del defecto.

El símbolo  indica que el producto debe ser eliminado en modo diferenciado del resto de los desechos urbanos.

ВНИМАНИЕ!

Безопасность прибора обеспечивается за счет правильного пользования настоящими инструкциями, поэтому необходимо их сохранять.

Перед началом работы на приборе всегда отключать напряжение.

Для очистки лампы не использовать абразивные продукты или агрессивные чистящие средства.

Если внешний кабель прибора поврежден, во избежание опасностей он должен быть заменен только изготовителем, его сервисной службой или равнозначным квалифицированным персоналом.

Kdln не выполняет никаких замен, если не было установлено происхождение дефекта.

Символ  указывает на то что данная продукция должна быть переработана отдельно от городских отходов.



IP20



Viceversa

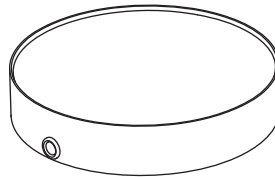
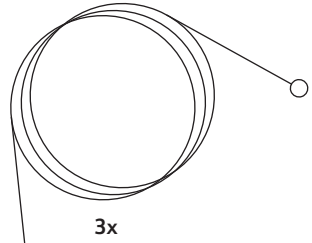
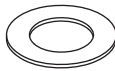
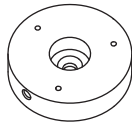
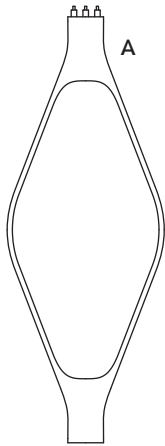

BOX N.1 - A

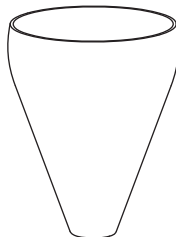

BOX N.2

Viceversa 2

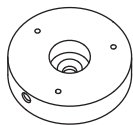
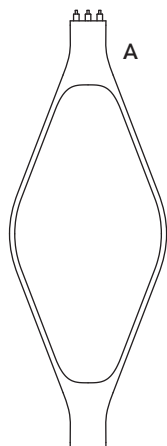

2x

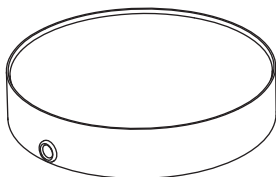
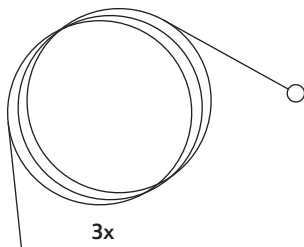
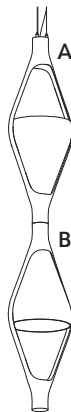

BOX N.1 - A

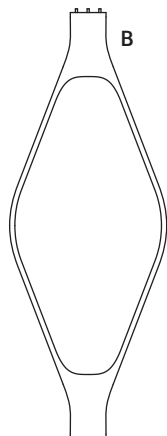

3x

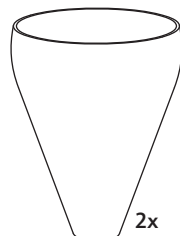

2x

BOX N.2 - B

BOX N.3 - 4

Viceversa

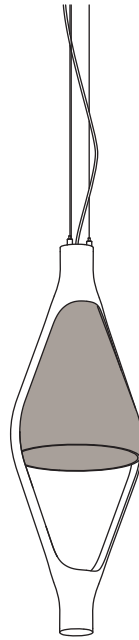
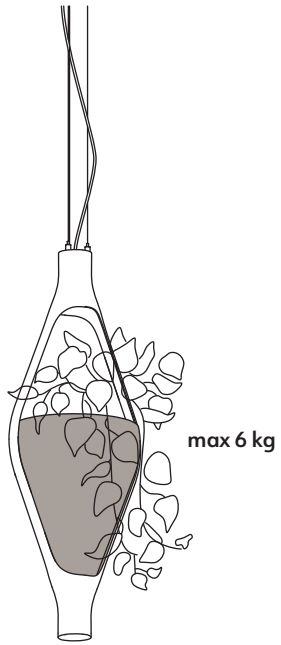

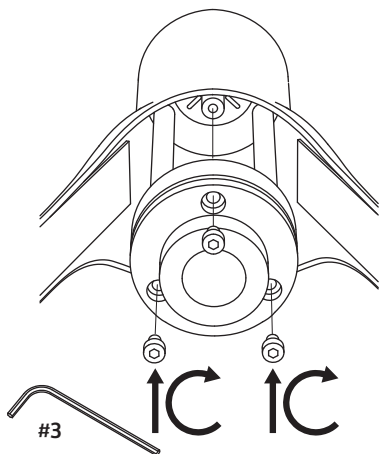
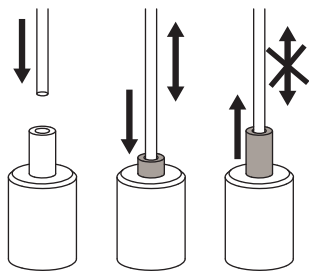
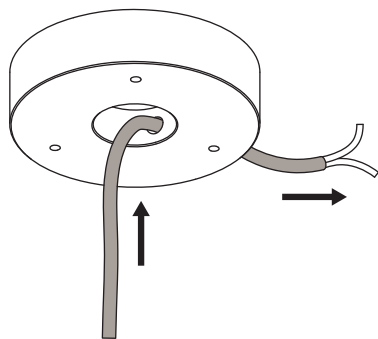
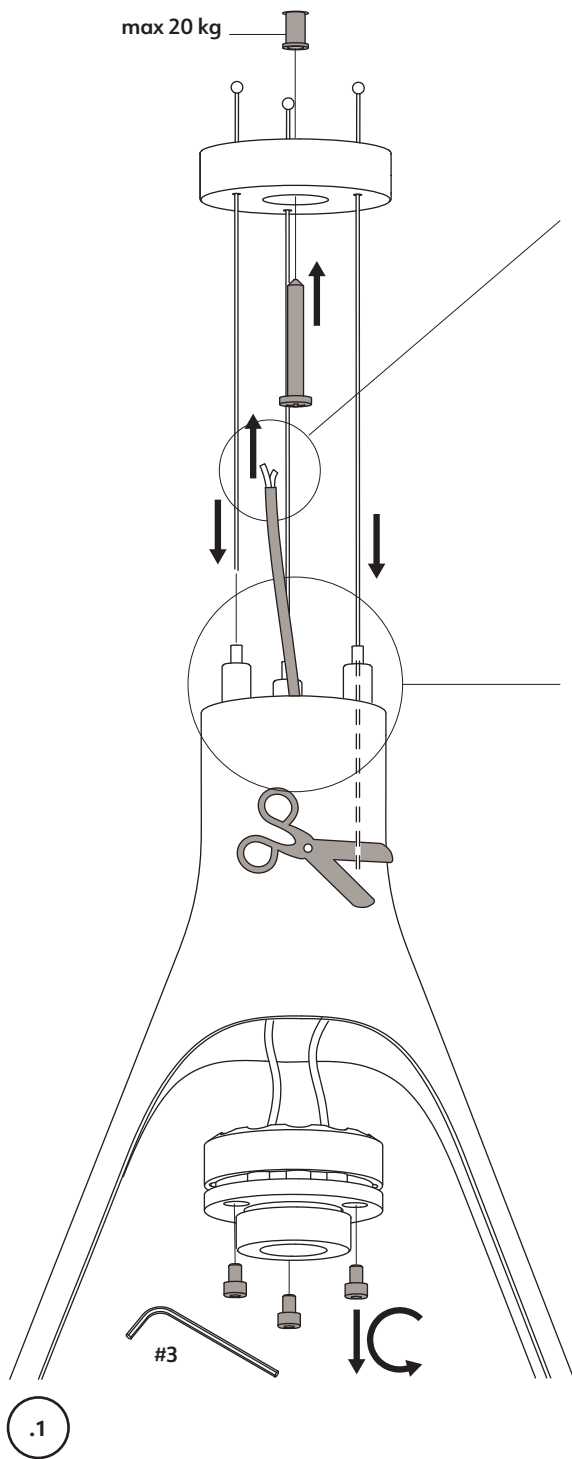

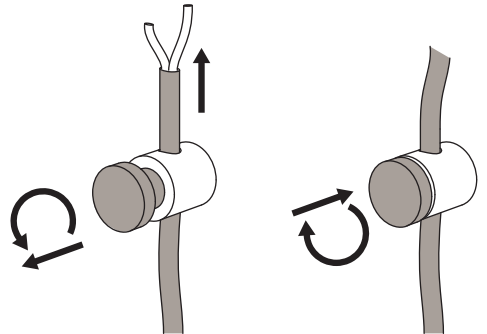
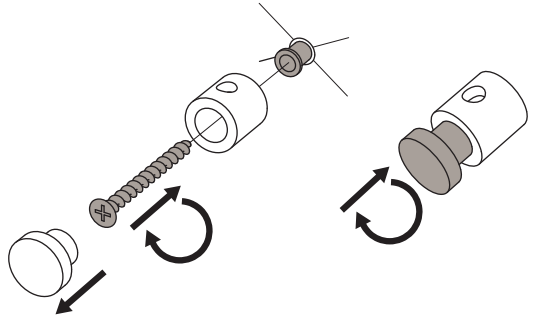
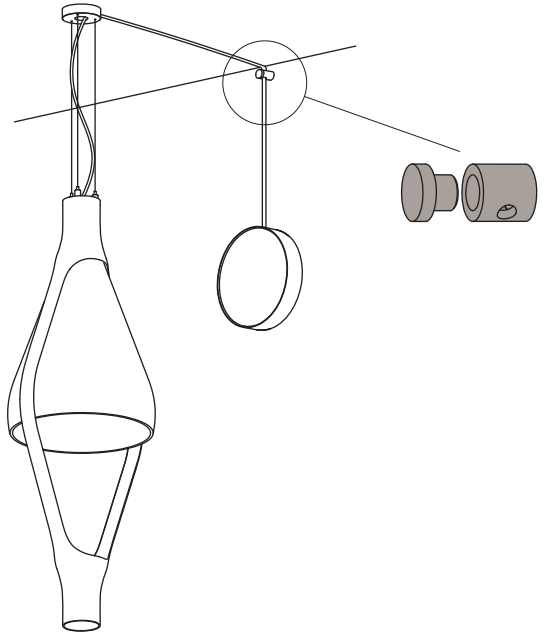
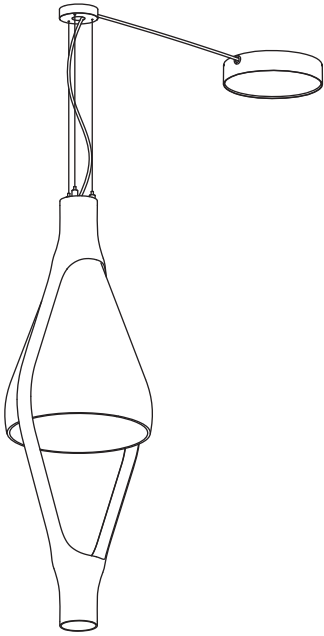

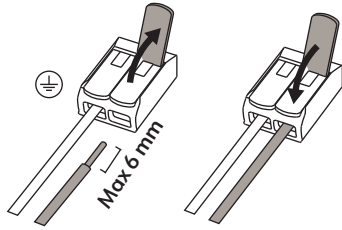
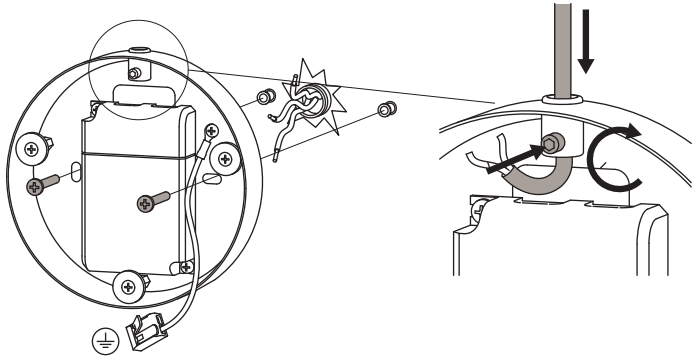
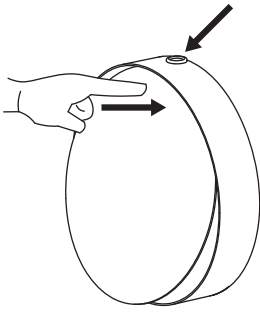

.3

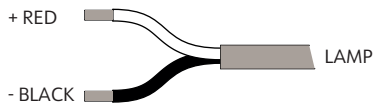
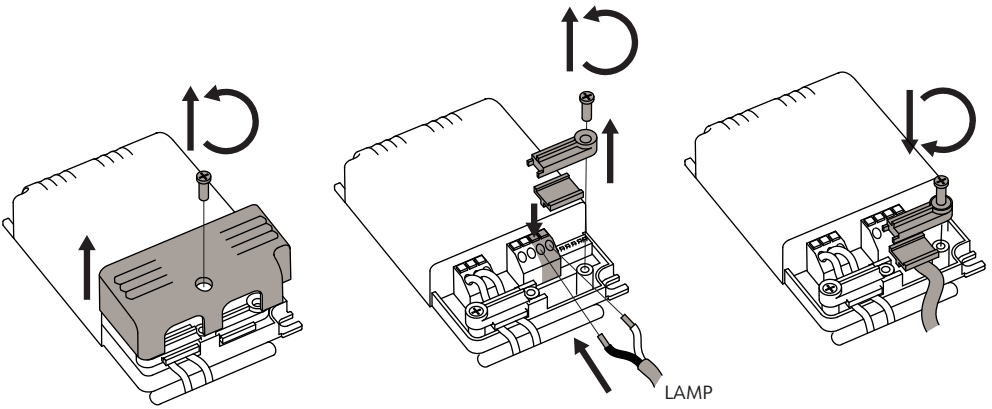

.4

ON-OFF wiring diagram

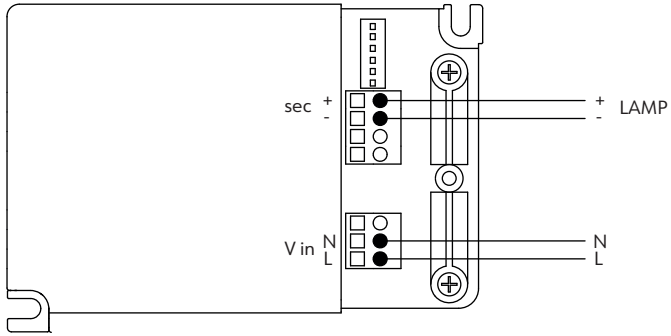

PUSH wiring diagram

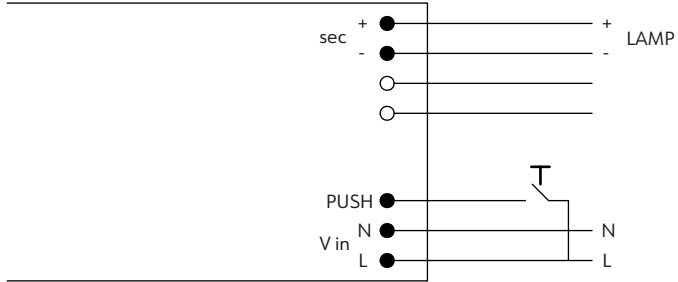

1-10V wiring diagram

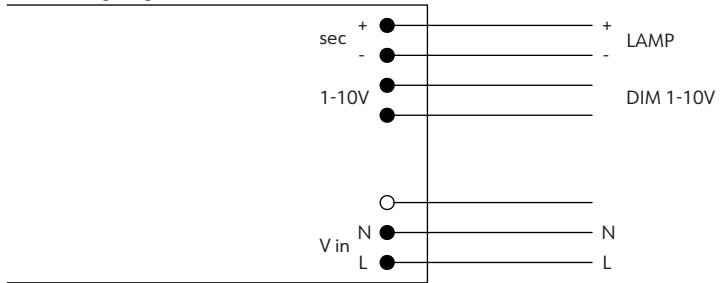

DALI wiring diagram

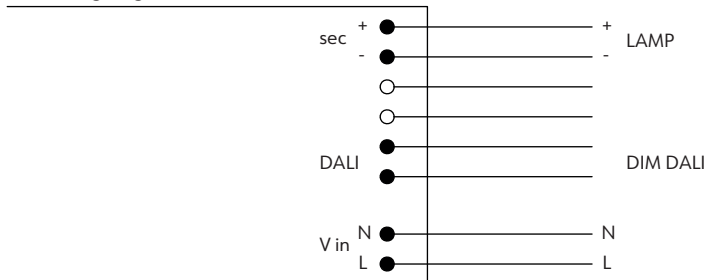

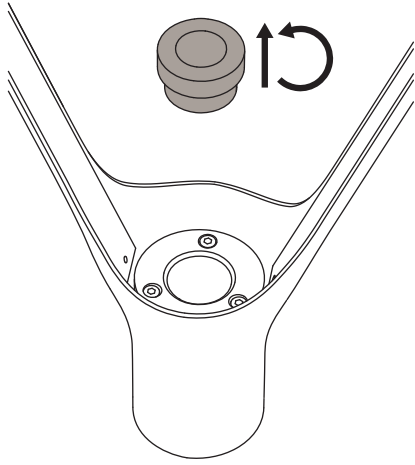

.6

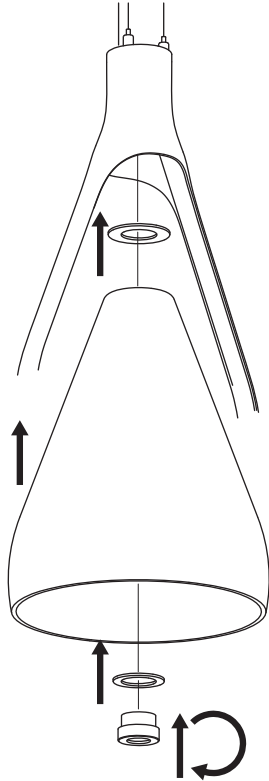
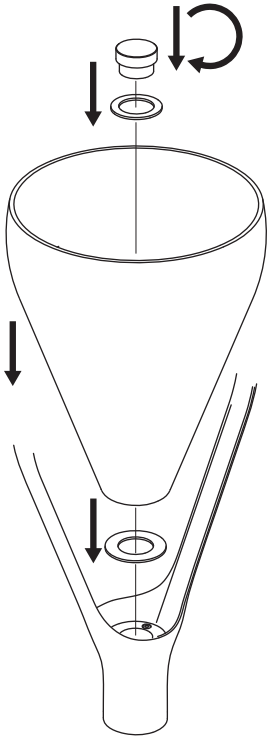

.7

Viceversa 2



120°



240°

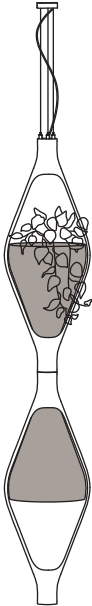
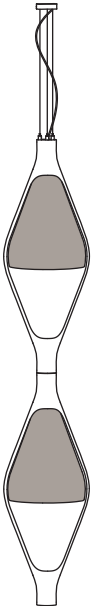

max 6 kg

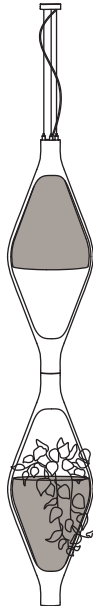

max 6 kg



max 6 kg

max 6 kg

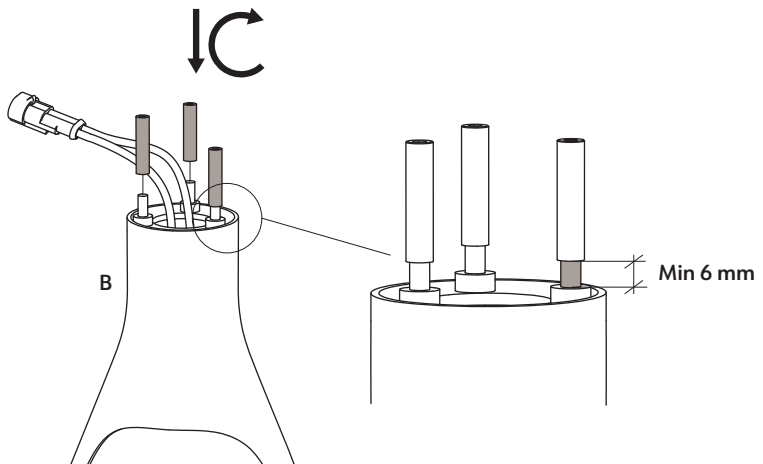
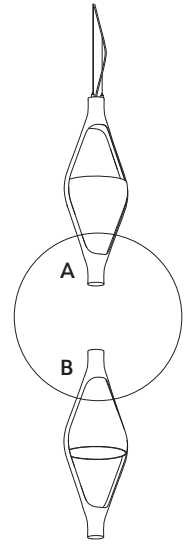
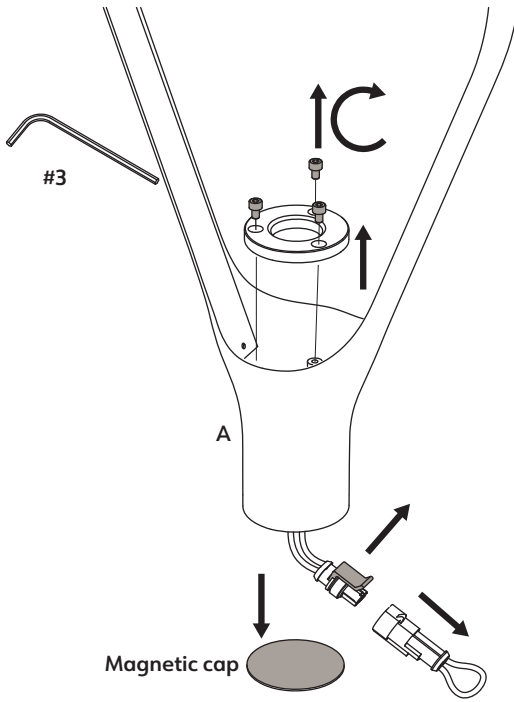

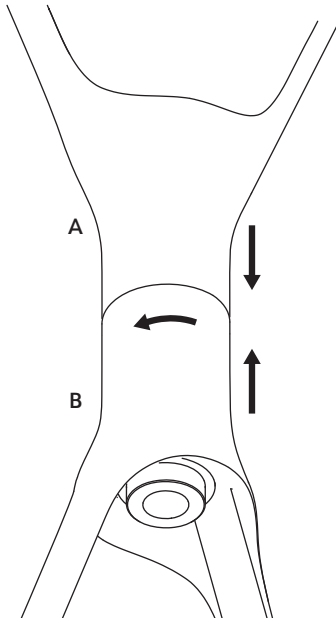
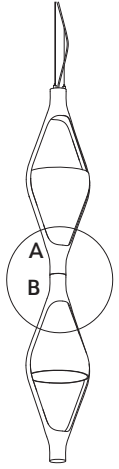
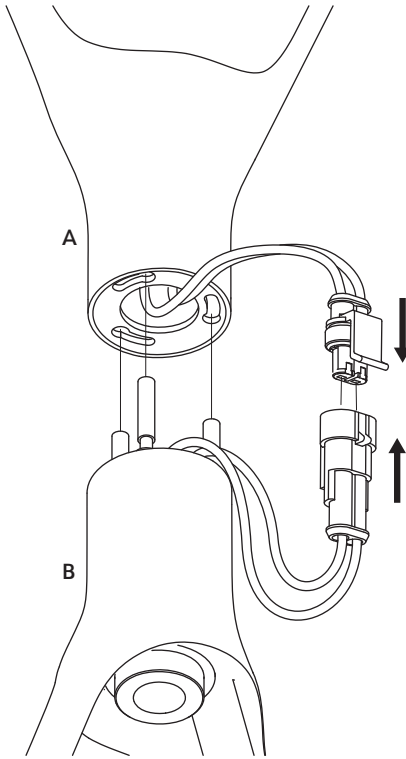

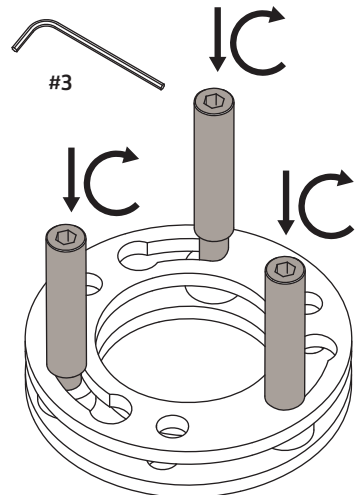
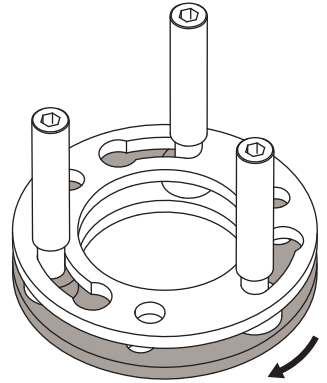
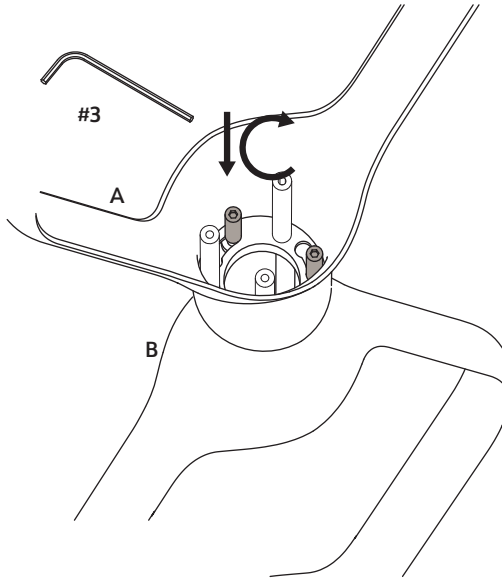
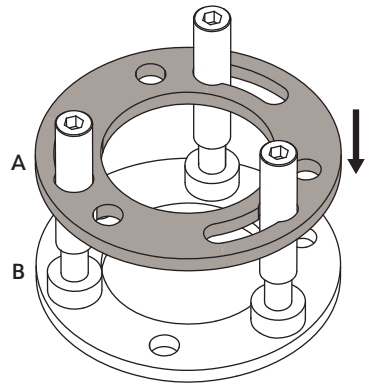

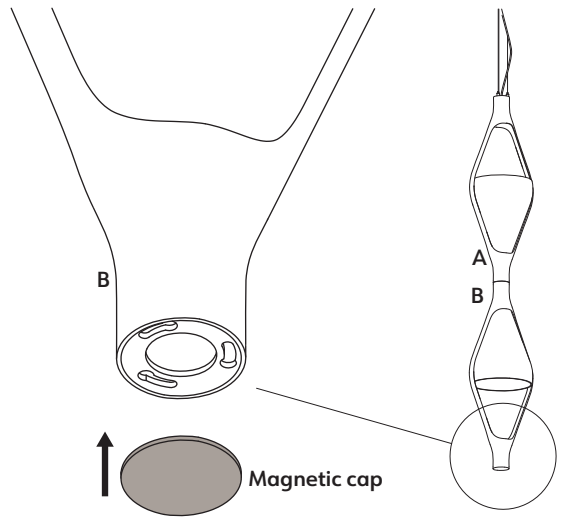
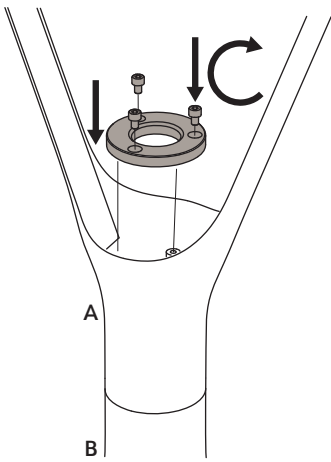

.11

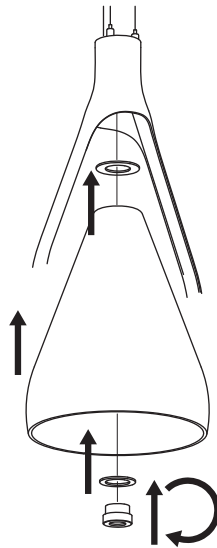
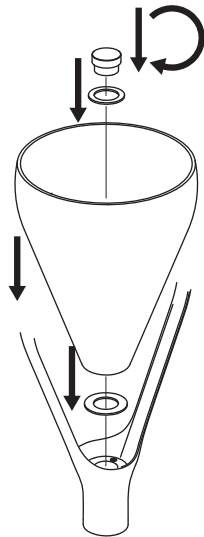

.12

BULBS, LAMPADINE, AMPOULES, LEUCHTENMITTEL, BOMBILLAS, ТИП ЛАМПОЧКИ

Viceversa
board LED 9W

Viceversa 2
board LED 16.5W

FEEDING, ALIMENTAZIONE, ALIMENTATION, SPANNUNG, TENSION DE RED, НАПРЯЖЕНИЕ
220-240 V

