

SERAX

Anita Le Grelle

TERRES DE REVES

PENDANT LAMP OLYMPIA N°4

MOUNTING INSTRUCTION MANUAL

B1924004-001

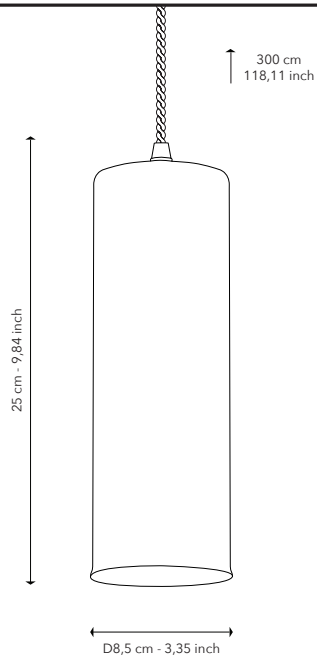

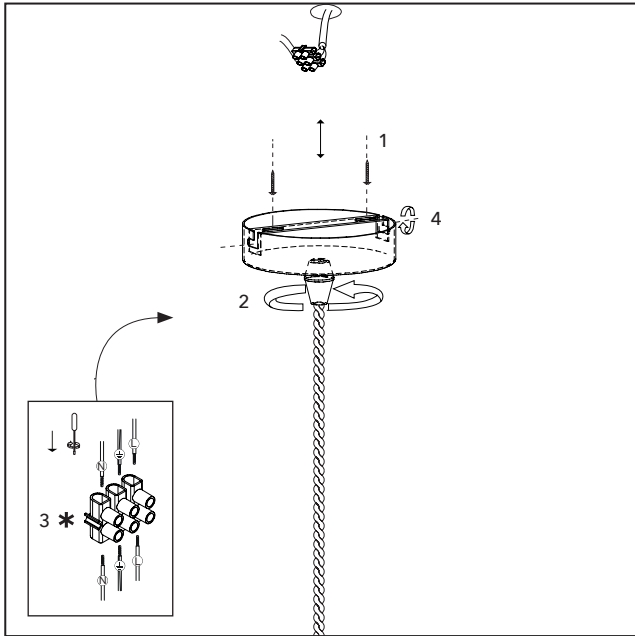

1.
 Intall bracket of ceiling rose.
 Connect wiring according
 electrical schedule.
 Close ceiling rose.

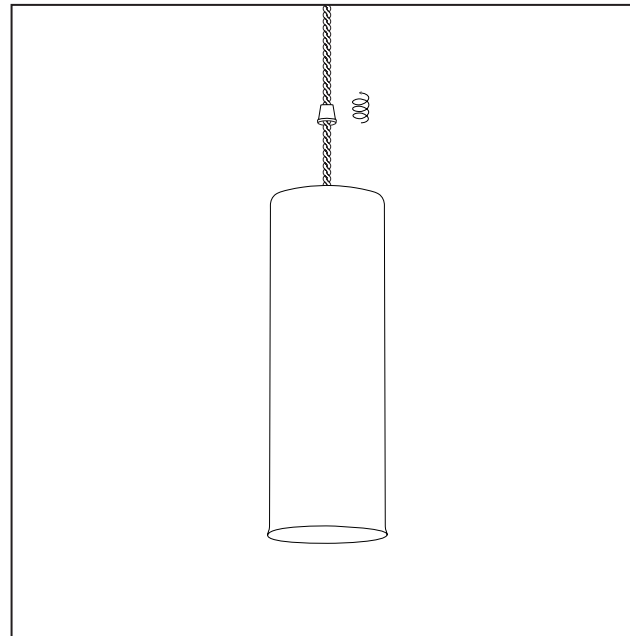

3.
 Loosen counterclockwise
 the top strain relief.

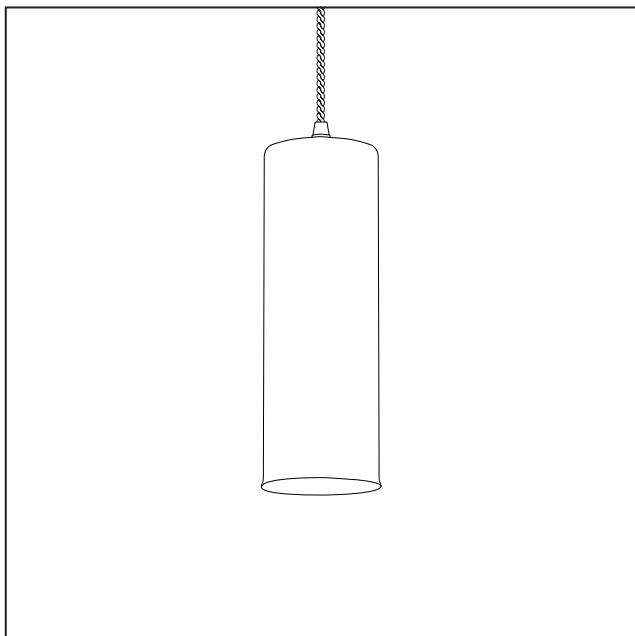

2.
 Take care of step 3/4/5 to
 insert an E14 bulb.

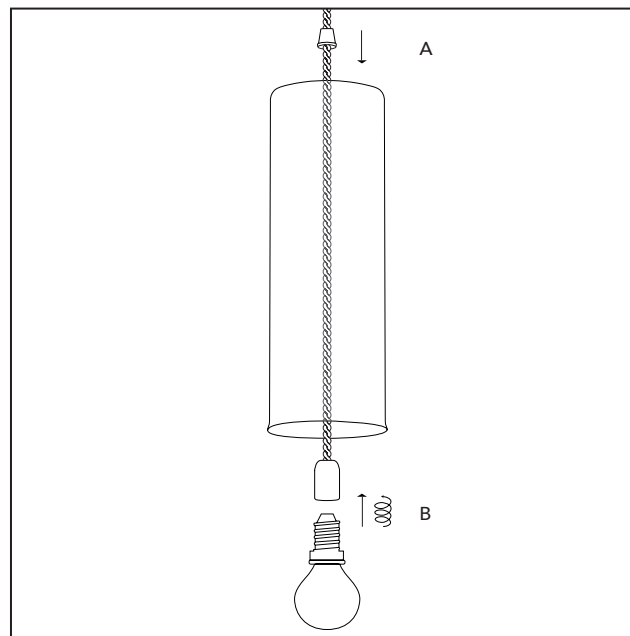

4.
 Lower the cord to insert the
 requested bulb.

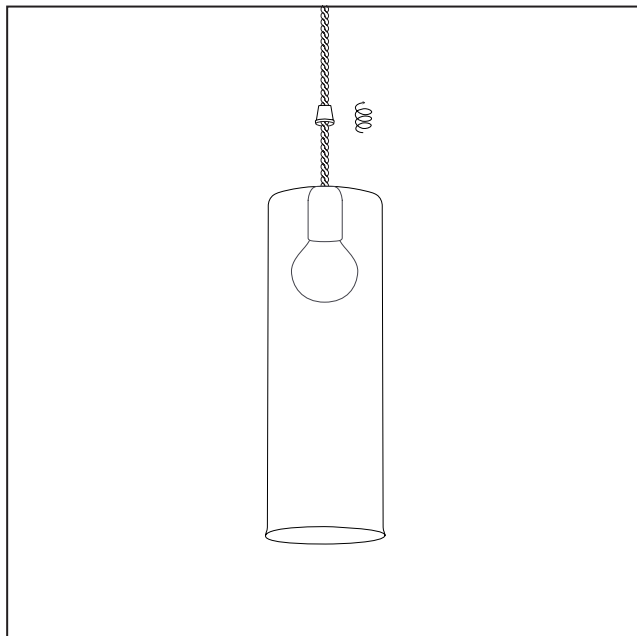

5.

Pull the cord backwards into the lampshade. Tighten the strain relief clockwise.

LUMINARY SPECS













TYPE	Pendant Lamp
COLOR	White
MATERIAL	Fine Bone China
DIMENSIONS	L8,5 W8,5 H25 cm L3,35 W3,35 H9,84 inch
WEIGHT	0,55 kg
SWITCH	No
DIMMABLE	No
BULB TYPE	E14
LIGHTBULB INLCUED	No
MAXIMUM VOLTAGE	240 Volt
MAXIMUM WATTAGE	5 W
CLASS	I

SAFETY DIRECTIONS

Please study the instruction manual and below information carefully before installing or using this product and keep this user manual for further reference.

1. The luminaires may only be installed by authorized and qualified technicians according the valid regulations for electrical installation.
2. Maintenance of the luminaires is limited to their surfaces. During maintenance no moisture can come into contact with any areas of the terminal connections or voltage control parts.
3. The electrical supply must be switched off at the outset, preferably by means of a switch in the distribution box, before any installation, maintenance or repair work is undertaken.
4. Exterior light must not be installed during rain.
5. Take account of the minimal separation distance from other objects and the room required around the fitting.
6. If in any doubt, consult a professional, taking local installation requirements into account. Some countries stipulate that lighting may be installed only by registered installers.
7. Clamping screws in electrical connections must be adequately tightened. This is particularly the case with 12V low voltage conductors.
8. When replacing a halogen lamp, wait for it to cool, for a minimum of 5 minutes.
9. Clean with a clean, dry cloth or brush, use no solvents or abrasives. Avoid dampness on all electrical components.
10. Take account of all available technical information.
11. Take note of the symbols when connecting wires:
N = Neutral
L = Live
 = Earth
12. If the external flexible cable or cord of this luminaire is damaged, it shall be exclusively replaced by the manufacturer or his service agent or a similar qualified person in order to avoid a hazard.

SYMBOLS & MEANINGS

-  For indoor use only, where direct contact with water is impossible.
-  Protection class 1: the fitting must be earthed.
-  Protection class 2: the fitting is double insulated and does not require earthing.
-  Protection class 3: the fitting is low voltage.
-  Observe the indicated minimum distance between the lamp and the illuminated materials/objects.
-  Only the self-screening halogen illuminants should be used with the luminaire.
-  Strip the wire to the indicated length.
-  Connect using the specified cable.
-  The fixture can be used in combination with a dimmer. Consult the sales outlet for the correct type of dimmer (important in the case of 12V fittings)
-  The maximum wattage indicated in each lighting unit, for example, must not be exceeded.
-  This luminaire cannot be disposed together with normal domestic waste, you have to bring it to a staging area for electrical waste.
-  This luminaire was designed to work only with the indicated voltage.
-  This shows that the products meets EU safety, health or environmental requirements.

SYMBOLS FOR THIS PRODUCT:



SERAX

VELDKANT 21, 2550 KONTICH, BELGIUM

SERAX.COM +32 3458 05 82